

aparici

OUTDOOR PORCELAIN STONEWARE SLABS - SOLUTIONS FOR OUTDOOR AREAS

GRES PORCELANICO PARA EXTERIOR - SOLUCIONES INTEGRALES PARA EXTERIORES

OUTDOOR LIVING PORCELAIN SLABS 20MM & 10MM



aparici

INSPIRING
DESIGN SINCE 1961

TEXTILE | TEXTIL

Bohemian	4
Carpet	8
Tex	12

CONCRETE | CEMENTO

Attila	28
Brave	32
Harlem	12
Studio	34

COTTO | COTTO

Cotto	40
-------	----

METAL | METAL

Metallic	48
Corten	52

STONE | PIEDRA

Dstone	14
Lithops	18
Ronda	22
Recover	26

ENCAUSTIC | HIDRÁULICO

Studio	34
Altea	36

WOOD | MADERA

Camper	44
--------	----

TECHNICAL | TÉCNICO

Installation Systems	58
Decor Shaped Pieces 2cm	60
Step Tiles 2cm & 1cm	62
Swimming Pool Pieces 2cm	64

EN

The **2CM Porcelain Stoneware Slabs** are ideal for outdoor pavings, including raised pavings. Hard-wearing and resistant to thermal shock, loads and stresses, our 2CM porcelain stoneware is highly suitable for paving terraces and balconies; and also for laying paths in outdoor areas. The perfect alternative to wood and stone that will remain absolutely unchanged over time.

All 2CM collections feature the matching 10mm porcelain tiles for indoor use in order to enable the possibility of creating unbroken visual continuity between outdoor and indoor spaces in any residential or commercial space. The indoor tile formats available include sizes 50x100cm, 100x100cm, 25x100cm and 60x60cm depending on the collection.

ES

El espesor de 2CM es ideal para pavimentos exteriores, incluidos los pavimentos sobreelevados. Resistente al desgaste, a los cambios bruscos de temperatura, las cargas y las sollicitaciones, nuestro porcelánico 2CM resulta adecuado para su colocación en terrazas y balcones, así como para realizar sendas en zonas de exterior. Perfecta alternativa a la madera y a la piedra, es un producto que no sufre alteraciones frente el paso del tiempo. Todas las colecciones en 2CM disponen de los pavimentos coordinados en porcelánico de 10mm para su uso en zonas de interior. Esto permitirá la posibilidad de crear una continuidad visual ininterrumpida entre espacios exteriores e interiores en cualquier espacio residencial o comercial. Los formatos disponibles para zonas de interior son 50x100cm, 100x100cm, 25x100cm y 60x60cm en función de la colección.

FR

L'épaisseur de 2 cm est idéale pour les sols extérieurs, y compris les sols surélevés. Résistant à l'usure, aux changements brusques de températures, de charges et de contraintes, nos carreaux de grés cérame 2CM conviennent pour son placement sur les terrasses et les balcons, ainsi que pour faire des allées dans les espaces extérieurs. Alternative parfaite au bois et la pierre, c'est un produit qui ne subit pas d'altérations avec le temps.

Toutes les collections 2CM ont des carreaux de sol en grés cérame de 10 mm coordonnés pour une utilisation dans des espaces intérieurs. Cela permettra la possibilité de créer une continuité visuelle ininterrompue entre les espaces extérieurs et intérieurs dans tout espace résidentiel ou commercial. Les formats disponibles pour les espaces intérieurs sont 50x100cm, 100x100cm, 25x100cm et 60x60cm selon la collection.

DE

Die 2CM-Feinsteinzeugplatten sind ideal für Verlegungen im Außenbereich sowie Stelzlager. Strapazierfähig und resistent gegen Hitze ist unser 2CM-Feinsteinzeug bestens geeignet für die Verlegung von Terrassen und Balkonen. Die perfekte Alternative zu Holz und Stein, die absolut unverändert bleibt.

Zu allen 2CM-Kollektionen gibt es die passenden 10-mm-Feinsteinzeugfliesen für den Innenbereich, so dass die Möglichkeit besteht, eine ununterbrochene visuelle Kontinuität zwischen Außen- und Innenbereichen in jedem Wohn- oder Geschäftsraum zu schaffen.

Die Innenfliesen sind je nach Kollektion in den Formaten 50x100cm, 100x100cm, 25x100cm und 60x60cm erhältlich.

2CM ADVANTAGES | 2CM VENTAJAS | AVANTAGES 2CM | 2CM VORTEILE

Compact monolithic slab 2cm thick squared and rectified.
Losa monolítica compacta de 2 cm de espesor, escuadrada y rectificada.



Dalle monolithique compacte de 2 cm d'épaisseur, quadrillée et rectifiée.
Kompakte Platte 2cm dick.

Easy to install.
Facil de colocar.



Facile à installer.
Leicht zu montieren.

Frost resistant.
Resistente a la helada.



Résistant au gel.
Frostbeständig.

High static load resistance.
Elevada resistencia a la Flexión.



Haute résistance à la flexion.
Hohe statische Belastbarkeit.

Thermal shock resistant.
Resistente a las variaciones térmicas.



Résistant aux variations thermiques.
Thermoschockbeständig.

Anti-Slip finish.
Acabado antideslizante.



Finition antidérapante.
Anti-Rutsch-Beschichtung.

Chemical attack resistance.
Resistente a productos químicos.



Résistant aux produits chimiques.
Beständigkeit gegen chemische Angriffe.

Removable and reusable.
Desmontable y reutilizable.



Amovible et réutilisable.
Abnehmbar und wiederverwendbar.

Eco-friendly.
Ecológico.



Écologique.
Umweltfreundlich.

BOHEMIAN

Textile



Floor: Bohemian Blue 2CM 49,75x99,55 cm



Floor: Bohemian Blend 2CM 49,75x99,55 cm

Textile

Colours | Colores | Couleurs | Farben



Bohemian Sand



Bohemian Blue



Bohemian Blend

Bohemian 50x100 consists of 26 different aleatory patterns.
Bohemian 50x100 se compone de 26 decoraciones diferentes aleatorias.

Porcelain | Porcelánico | Grés Cérame | Feinsteinzeug
Rectified | Rectificado | Rectifié | Rektifiziert
Moderate Variation | Moderada Variación | Variation Modérée | Leichte bis moderate Farbvariation

Size & Thickness | Formato & Espesor | Format & Épaisseur | Format & Dicke

20MM

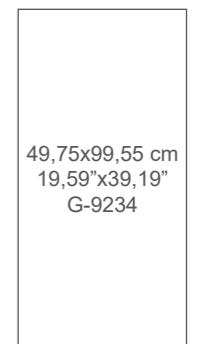

Outdoor Anti-Slip Value | Valor Anti-Slip | Valeur Antidérapantes | Anti-Rutsch-Wert

UNE-ENV 12633

CLASE 3

DIN 51130

R11 A+B+C

ANSI A 137.1

DCOF>0.42

BS 7976

PTV > 36



CARPET



Floor: Carpet Sand 2CM 50x100 cm



Floor: Carpet Vestige 2CM 50x100 cm
Wall: Brave Ivory Natural 49,75x99,55 cm

Textile

Colours | Colores | Couleurs | Farben



Carpet Sand



Carpet Vestige

Carpet 50x100 consists of 16 different aleatory patterns.
Carpet 50x100 se compone de 16 decoraciones diferentes aleatorias.

Porcelain | Porcelánico | Grés Cérame | Feinsteinzeug
Straight Edge | Ángulo Recto | Angle Droit | Rektifiziert
High Variation | Contraste de Tonalidad | Variation Forte | Hohe Farbvariation

Size & Thickness | Formato & Espesor | Format & Épaisseur | Format & Dicke

20MM

50x100 cm
19,69"x39,37"
G-9234

Outdoor Anti-Slip Value | Valor Anti-Slip | Valeur Antidérapantes | Anti-Rutsch-Wert

UNE-ENV 12633

CLASE 3

DIN 51130

R11 A+B+C

ANSI A 137.1

DCOF>0.42

BS 7976

PTV > 36





TEX

Textile

Colours | Colores | Couleurs | Farben



Tex Ivory



Tex Ivory Pattern

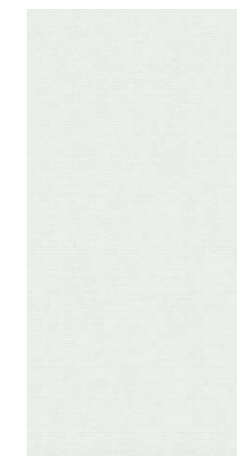

Tex Grey



Tex Grey Pattern

Tex Ivory & Grey Pattern 2cm consists of 16 different aleatory patterns.
Tex Ivory & Grey Pattern 2cm 50x100 se compone de 16 decoraciones diferentes aleatorias.

Porcelain | Porcelánico | Grés Cérame | Feinsteinzeug
Rectified | Rectificado | Rectifié | Rektifiziert
Slight Variation | Ligera Variación | Variation Modérée | Leichte Farbvariation
High Variation | Contraste de Tonalidad | Variation Forte | Hohe Farbvariation (Pattern)

Size & Thickness | Formato & Espesor | Format & Épaisseur | Format & Dicke

20MM

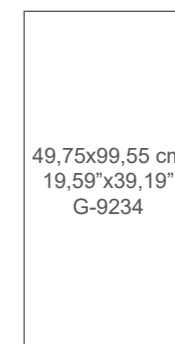

Outdoor Anti-Slip Value | Valor Anti-Slip | Valeur Antidérapantes | Anti-Rutsch-Wert

UNE-ENV 12633
CLASE 3

DIN 51130
R11 A+B+C

ANSI A 137.1
DCOF>0.42

BS 7976
PTV > 36



Outdoor Tile, Tex Ivory Pattern 2CM 49,75x99,55 cm
Indoor Tile 1CM: Tex Ivory Pattern Natural 99,55x99,55 cm

DSTONE



Floor: Dstone Sand Music 2CM 49,75x99,55 cm

Stone



Floor: Dstone Ash Lekue 2CM 49,75x99,55 cm_Tipo L_Grid_Esagono



Floor: Dstone Anthracite Moon 2CM 49,75x99,55 cm

Stone

Colours | Colores | Couleurs | Farben



Dstone Sand Music



Dstone Ash Lekue



Dstone Anthracite Moon

Porcelain | Porcelánico | Grés Cérame | Feinsteinzeug
 Rectified | Rectificado | Rectifié | Rektifiziert
 Moderate Variation | Moderada Variación | Variation Modérée | Leichte bis moderate Farbvariation

Size & Thickness | Formato & Espesor | Format & Épaisseur | Format & Dicke

20MM

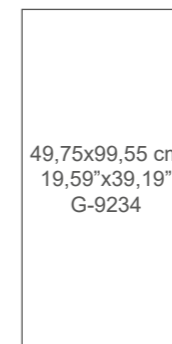

49,75x99,55 cm
 19,59"x39,19"
 G-9234

10MM

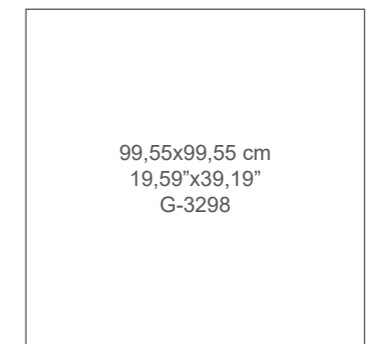

99,55x99,55 cm
 19,59"x39,19"
 G-3298

Indication of references in Anti-Slip R11 in 10mm.
 For further references in Natural finish in 10mm you can refer to our Floor Tiles General Catalogue.
 Indicación de modelos con acabado Clase 3 (Anti-Slip) en 10 mm.
 Para descubrir más formatos en 10mm con acabado natural, consulte nuestro Catálogo General de Pavimentos.

Outdoor Anti-Slip Value | Valor Anti-Slip | Valeur Antidérapantes | Anti-Rutsch-Wert

UNE-ENV 12633

CLASE 3

DIN 51130

R11 A+B+C

ANSI A 137.1

DCOF>0.42

BS 7976

PTV > 36



LITHOPS

Stone

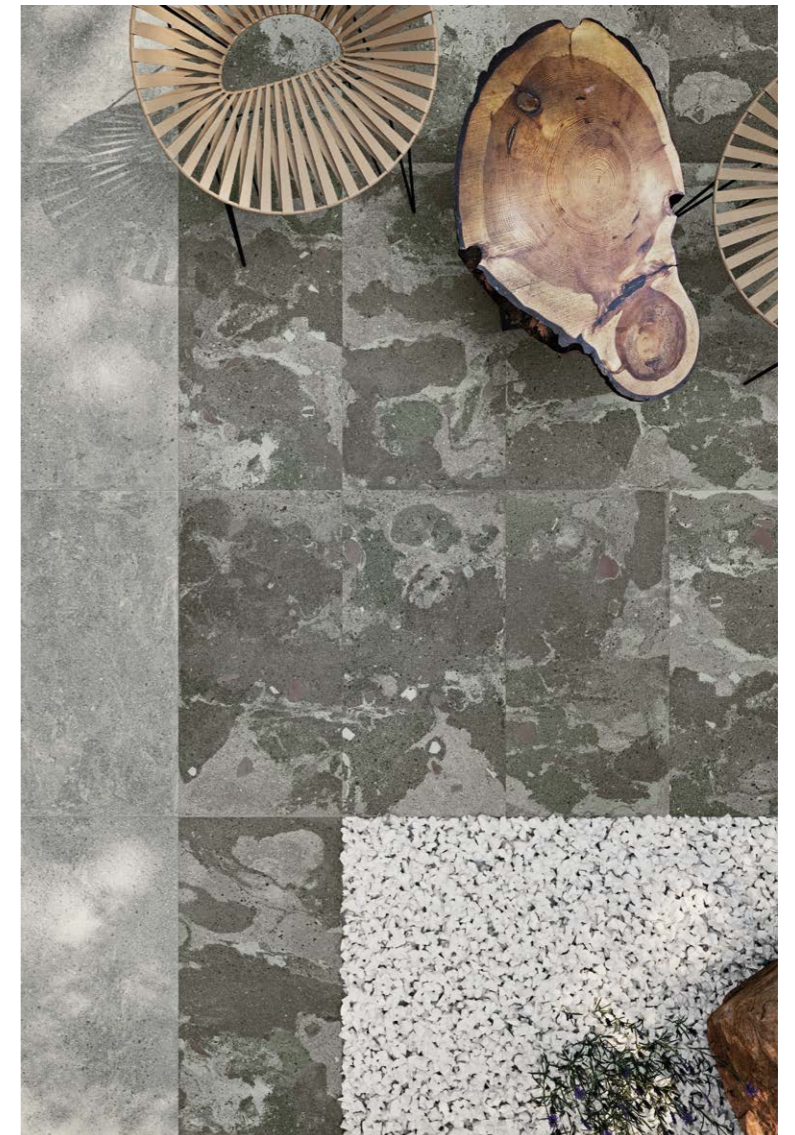

Outdoor Tile: Lithops Hopi Stamp 2CM 49,75x99,55 cm
Indoor Tile 1CM: Lithops Grey Natural 99,55x99,55 cm



Wall: Lithops Lipan Stamp 2CM 49,75x99,55 cm
 Floor: Lithops Ivory 2CM 49,75x99,55 cm

Stone

Colours | Colores | Couleurs | Farben



Lithops Ivory

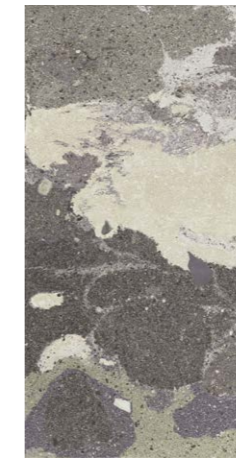

Lithops Lipan Stamp



Lithops Grey



Lithops Hopi Stamp

Lithops Stamp 50x100 consists of 32 different aleatory patterns.
 Lithops Stamp 50x100 se compone de 32 decoraciones diferentes aleatorias.

Porcelain | Porcelánico | Grés Cérame | Feinsteinzeug
Rectified | Rectificado | Rectifié | Rektifiziert
Slight Variation | Ligera Variación | Variation Légère | Leichte Farbvariation (Ivory & Grey)
Moderate Variation | Moderada Variación | Variation Modérée | Leichte bis moderate Farbvariation (Lipan & Hopi)

Size & Thickness | Formato & Espesor | Format & Épaisseur | Format & Dicke

20MM

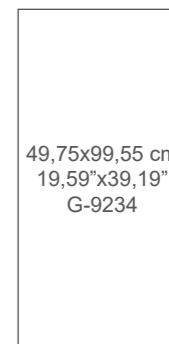

Outdoor Anti-Slip Value | Valor Anti-Slip | Valeur Antidérapantes | Anti-Rutsch-Wert

UNE-ENV 12633

CLASE 3

DIN 51130

R11 A+B+C

ANSI A 137.1

DCOF>0.42

BS 7976

PTV > 36



RONDA

Stone



Outdoor Tile: Ronda Ivory 2CM 49,75x99,55 cm
Indoor Tile 1CM: Ronda Ivory 49,75x99,55 cm

Ronda

Stone

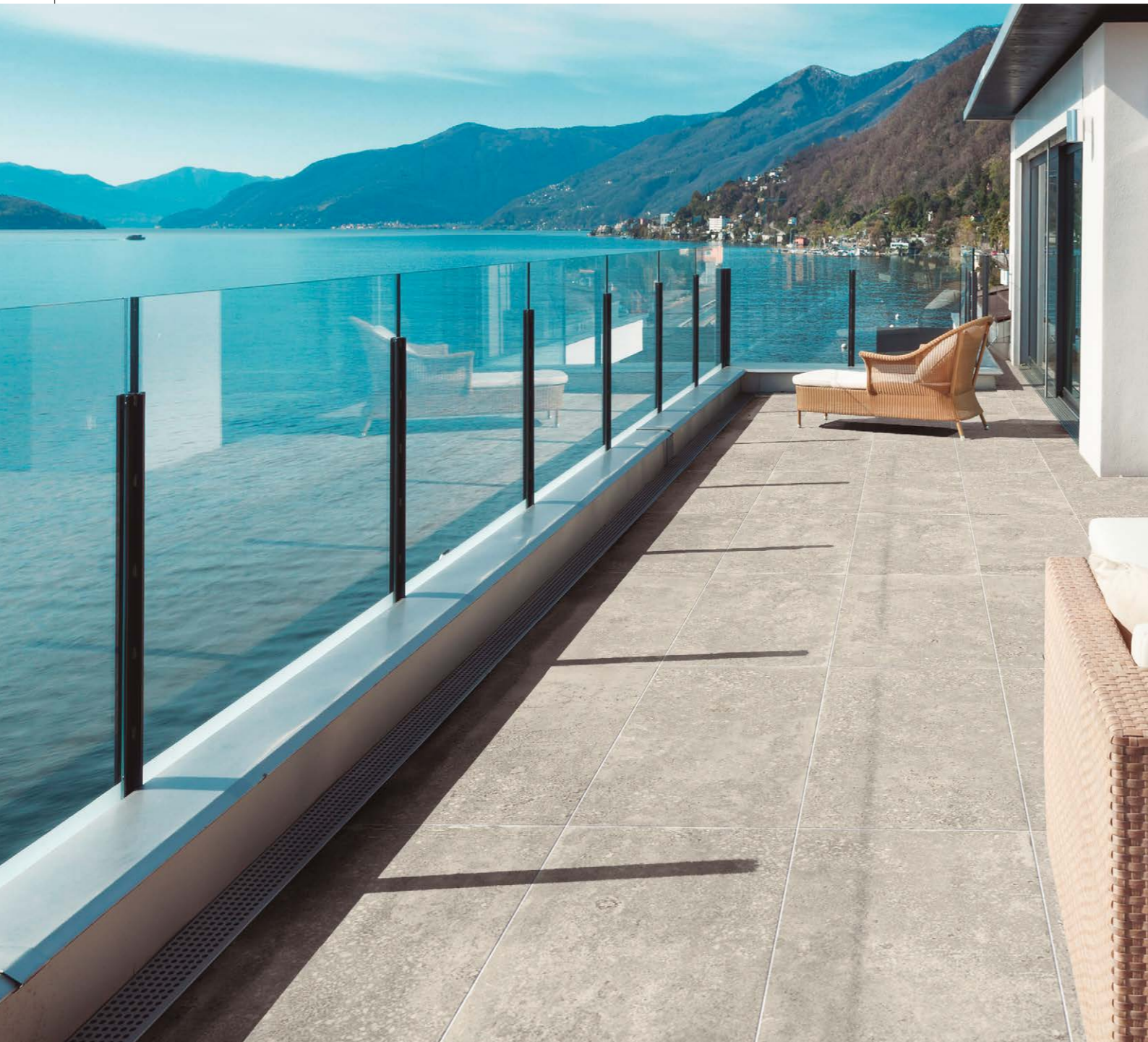

Colours | Colores | Couleurs | Farben



Ronda Ivory



Ronda Beige



Ronda Grey

Porcelain | Porcelánico | Grés Cérame | Feinsteinzeug
 Rectified | Rectificado | Rectifié | Rektifiziert
 Slight Variation | Ligera Variación | Variation Légère | Leichte Farbvariation

Size & Thickness | Formato & Espesor | Format & Épaisseur | Format & Dicke

20MM

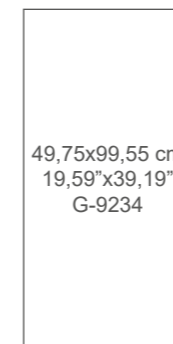

10MM

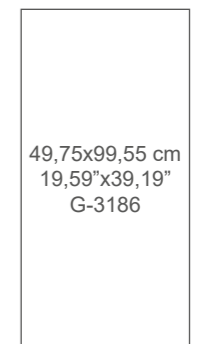
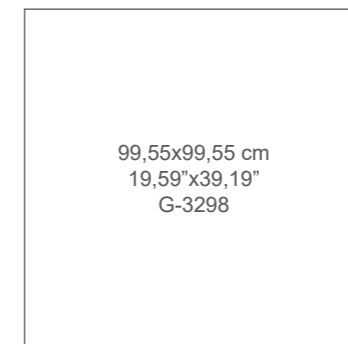

Indication of references in Anti-Slip R11 in 10mm.
 For further references in Natural finish in 10mm you can refer to our Floor Tiles General Catalogue.
 Indicación de modelos con acabado Clase 3 (Anti-Slip) en 10 mm.
 Para descubrir más formatos en 10mm con acabado natural, consulte nuestro Catálogo General de Pavimentos.

Outdoor Anti-Slip Value | Valor Anti-Slip | Valeur Antidérapantes | Anti-Rutsch-Wert

UNE-ENV 12633

CLASE 3

DIN 51130

R11 A+B+C

ANSI A 137.1

DCOF>0.42

BS 7976

PTV > 36



Floor: Ronda Grey 2CM 49,75x99,55 cm

RECOVER



Stone

Colours | Colores | Couleurs | Farben



Recover Ivory



Recover Grey



Recover Vison

Porcelain | Porcelánico | Grés Cérame | Feinsteinzeug
 Rectified | Rectificado | Rectifié | Rektifiziert
 Slight Variation | Ligera Variación | Variation Légère | Leichte Farbvariation

Size & Thickness | Formato & Espesor | Format & Épaisseur | Format & Dicke

20MM

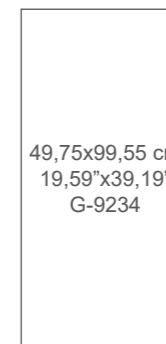

49,75x99,55 cm
 19,59"x39,19"
 G-9234

10MM

(Ivory & Grey)

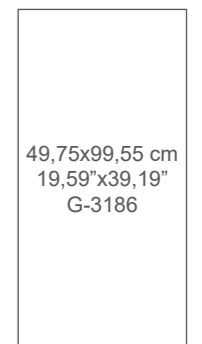

49,75x99,55 cm
 19,59"x39,19"
 G-3186

Indication of references in Anti-Slip R11 in 10mm.
 For further references in Natural finish in 10mm you can refer to our Floor Tiles General Catalogue.
 Indicación de modelos con acabado Clase 3 (Anti-Slip) en 10 mm.
 Para descubrir más formatos en 10mm con acabado natural, consulte nuestro Catálogo General de Pavimentos.

Outdoor Anti-Slip Value | Valor Anti-Slip | Valeur Antidérapantes | Anti-Rutsch-Wert

UNE-ENV 12633

CLASE 3

DIN 51130

R11 A+B+C

ANSI A 137.1

DCOF>0.42

BS 7976

PTV > 36



Outdoor Tile: Recover Ivory Natural 2CM 49,75x99,55 cm
 Indoor Tile 1CM: Recover Ivory Natural 99,55x99,55 cm



Outdoor Tile: Attila Grey 2CM 49,75x99,55 cm
Indoor Tile 1CM: Attila Grey Natural 49,75x99,55 cm

Attila

Concrete

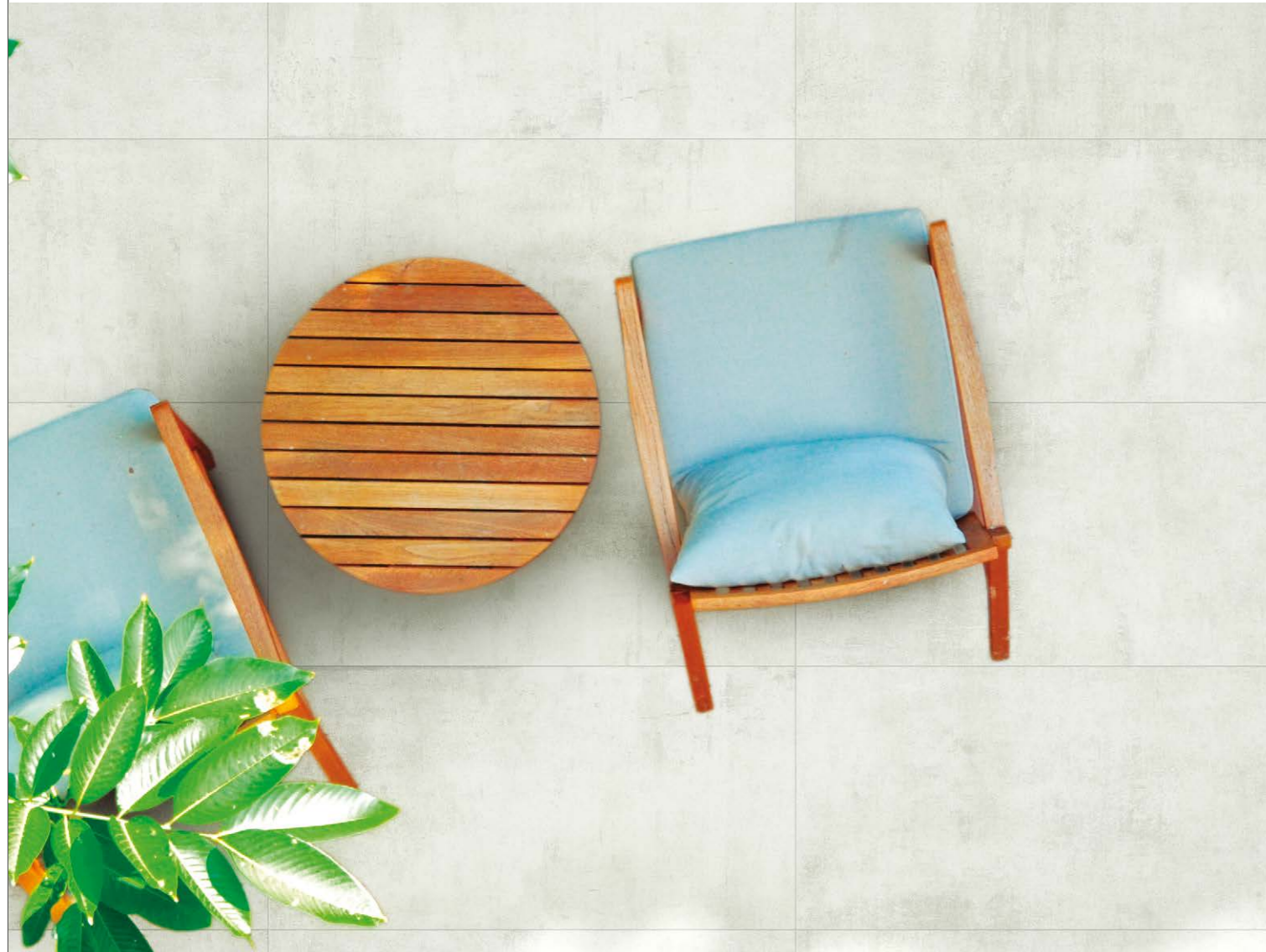

Colours | Colores | Couleurs | Farben



Attila Ivory



Attila Grey



Attila Anthracite

Porcelain | Porcelánico | Grés Cérame | Feinsteinzeug
 Rectified | Rectificado | Rectifié | Rektifiziert
 Slight Variation | Ligera Variación | Variation Légère | Leichte Farbvariation

Size & Thickness | Formato & Espesor | Format & Épaisseur | Format & Dicke

20MM

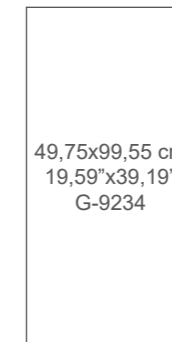

10MM

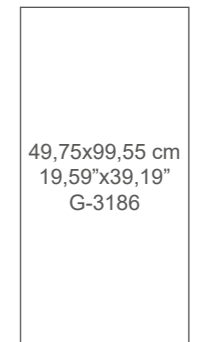

Indication of references in Anti-Slip R11 in 10mm.
 For further references in Natural finish in 10mm you can refer to our Floor Tiles General Catalogue.
 Indicación de modelos con acabado Clase 3 (Anti-Slip) en 10 mm.
 Para descubrir más formatos en 10mm con acabado natural, consulte nuestro Catálogo General de Pavimentos.

Outdoor Anti-Slip Value | Valor Anti-Slip | Valeur Antidérapantes | Anti-Rutsch-Wert

UNE-ENV 12633

CLASE 3

DIN 51130

R11 A+B+C

ANSI A 137.1

DCOF>0.42

BS 7976

PTV > 36



Floor: Attila Ivory 2CM 49,75x99,55 cm

BRAVE



Outdoor Tile: Brave Ivory 2CM 49,75x99,55 cm
Indoor Tile 1CM: Brave Ivory Natural 99,55x99,55 cm

Concrete

Colours | Colores | Couleurs | Farben

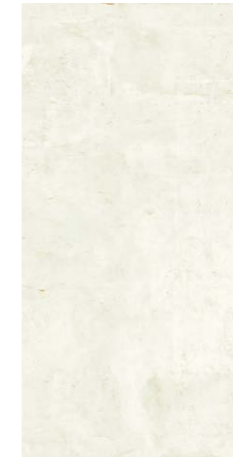

Brave Ivory



Brave Grey



Brave Vison

Porcelain | Porcelánico | Grés Cérame | Feinsteinzeug
Rectified | Rectificado | Rectifié | Rektifiziert
Slight Variation | Ligera Variación | Variation Légère | Leichte Farbvariation

Size & Thickness | Formato & Espesor | Format & Épaisseur | Format & Dicke

20MM

49,75x99,55 cm
19,59"x39,19"
G-9234

Outdoor Anti-Slip Value | Valor Anti-Slip | Valeur Antidérapantes | Anti-Rutsch-Wert

UNE-ENV 12633

CLASE 3

DIN 51130

R11 A+B+C

ANSI A 137.1

DCOF>0.42

BS 7976

PTV > 36





Concrete

Colours | Colores | Couleurs | Farben



Studio Ivory



Studio Grey



Studio Anthracite



Studio Stamp

Studio Stamp Outdoor 2cm consists of 9 different aleatory patterns.
Studio Stamp Outdoor 2cm se compone de 9 decoraciones diferentes aleatorias.

Porcelain | Porcelánico | Grés Cérame | Feinsteinzeug
Rectified | Rectificado | Rectifié | Rektifiziert
Slight Variation | Ligera Variación | Variation Légère | Leichte Farbvariation

Size & Thickness | Formato & Espesor | Format & Épaisseur | Format & Dicke

20MM

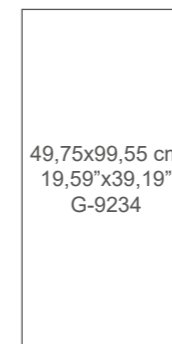

10MM

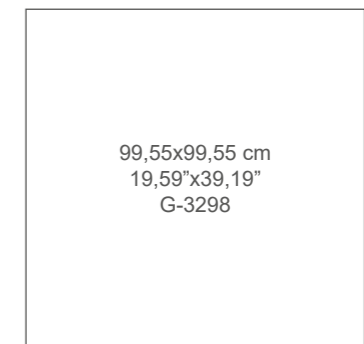

Indication of references in Anti-Slip R11 in 10mm.
For further references in Natural finish in 10mm you can refer to our Floor Tiles General Catalogue.
Indicación de modelos con acabado Clase 3 (Anti-Slip) en 10 mm.
Para descubrir más formatos en 10mm con acabado natural, consulte nuestro Catálogo General de Pavimentos.

Outdoor Anti-Slip Value | Valor Anti-Slip | Valeur Antidérapantes | Anti-Rutsch-Wert

UNE-ENV 12633

CLASE 3

DIN 51130

R11 A+B+C

ANSI A 137.1

DCOF>0.42

BS 7976

PTV > 36



Outdoor Tile: Studio Stamp 2CM 49,75x99,55 cm
Indoor Tile 1CM: Studio Ivory Natural 49,75x99,55 cm

ALTEA

Encaustic



Wall: Corten Iron Natural 99,55x99,55 cm
Floor: Altea Olivo 2CM 49,75x99,55 cm - Altea Olivo 2cm Grid - Corten Iron Natural 99,55x99,55 cm

Altea

Encaustic



Colours | Colores | Couleurs | Farben



Altea Olivo



Altea Alba



Altea Corbeta



Altea Puerto



Altea Elda



Altea Pinar

Porcelain | Porcelánico | Grés Cérame | Feinsteinzeug
Rectified | Rectificado | Rectifié | Rektifiziert
Slight Variation | Ligera Variación | Variation Modérée | Leichte Farbvariation

Size & Thickness | Formato & Espesor | Format & Épaisseur | Format & Dicke

20MM

49,75x99,55 cm
19,59"x39,19"
G-9234

Outdoor Anti-Slip Value | Valor Anti-Slip | Valeur Antidérapantes | Anti-Rutsch-Wert

UNE-ENV 12633

CLASE 3

DIN 51130

R11 A+B+C

ANSI A 137.1

DCOF>0.42

BS 7976

PTV > 36



Floor: Altea Elda 2CM 49,75x99,55 cm-Altea Puerto 2CM Tipo L 100-Altea Puerto Natural 59,2x59,2 cm

Floor: Altea Corbeta 2CM 49,75x99,55 cm

COTTO



Outdoor Tile: Cotto Rosso 2CM 50x100 cm
Indoor Tile 1CM: Cotto Rosso Natural 50x100 cm - Cotto Sand Natural Rodapié 100

Cotto

Cotto



Colours | Colores | Couleurs | Farben



Cotto Sand



Cotto Brown



Cotto Rosso

Porcelain | Porcelánico | Grés Cérame | Feinsteinzeug
 Straight Edge | Ángulo Recto | Angle Droit | Rechter Winkel
 Moderate Variation | Moderada Variación | Variation Forte | Leichte bis moderate Farbvariation

Size & Thickness | Formato & Espesor | Format & Épaisseur | Format & Dicke

20MM

10MM

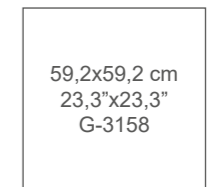
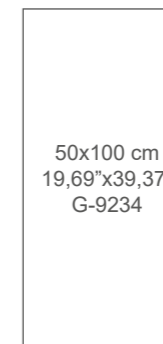

Indication of references in Anti-Slip R11 in 10mm.
 For further references in Natural finish in 10mm you can refer to our Floor Tiles General Catalogue.
 Indicación de modelos con acabado Clase 3 (Anti-Slip) en 10 mm.
 Para descubrir más formatos en 10mm con acabado natural, consulte nuestro Catálogo General de Pavimentos.

Outdoor Anti-Slip Value | Valor Anti-Slip | Valeur Antidérapantes | Anti-Rutsch-Wert

UNE-ENV 12633

CLASE 3

DIN 51130

R11 A+B+C

ANSI A 137.1

DCOF>0.42

BS 7976

PTV > 36



Outdoor Tile: Cotto Sand 2CM 50x100 cm
 Indoor Tile 1CM: Cotto Sand Natural 50x100 cm_Cotto Sand Nat. Rodapié 100 8x100 cm

CAMPER



Floor: Camper Ash 2CM 49,75x99,55 cm - Camper Ash Grid - Camper Ash Tipo L



Wood

Colours | Colores | Couleurs | Farben



Camper White



Camper Ash



Camper Savanna

Porcelain | Porcelánico | Grés Cérame | Feinsteinzeug
 Rectified | Rectificado | Rectifié | Rektifiziert
 Slight Variation | Ligera Variación | Variation Modérée | Leichte Farbvariation

Size & Thickness | Formato & Espesor | Format & Épaisseur | Format & Dicke

20MM

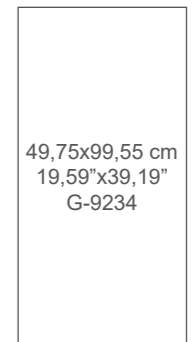

Outdoor Anti-Slip Value | Valor Anti-Slip | Valeur Antidérapantes | Anti-Rutsch-Wert

UNE-ENV 12633

CLASE 3

DIN 51130

R11 A+B+C

ANSI A 137.1

DCOF>0.42

BS 7976

PTV > 36



Outdoor Tile: Camper Savanna 2CM 49,75x99,55 cm
 Indoor Tile 1CM: Camper Savanna Natural 24,75x99,55 cm

METALLIC

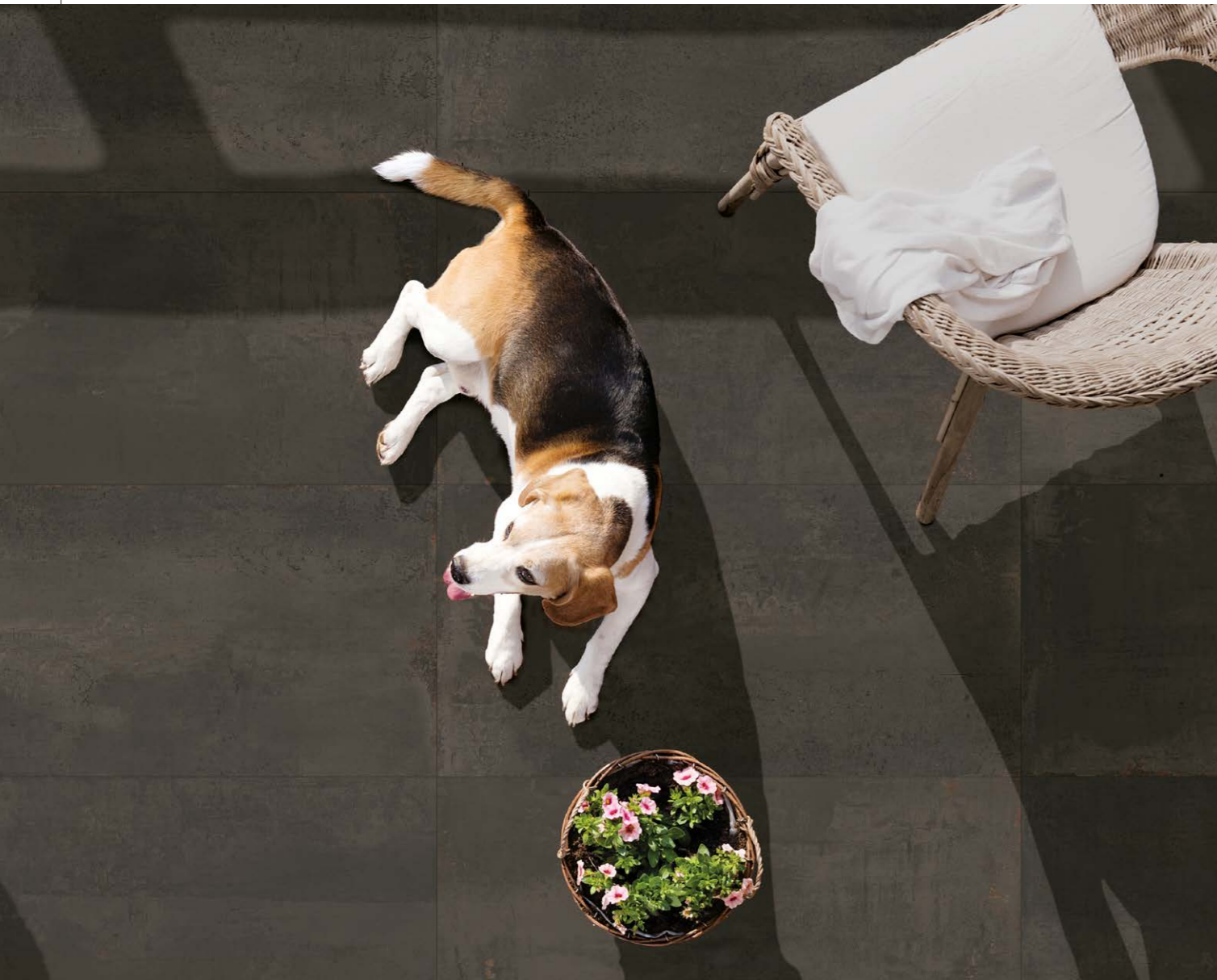

Floor: Metallic Brown 2CM 49,75x99,55 cm

Metal



Floor: Metallic Green 2CM 49,75x99,55 cm - Metallic Green Grid



Floor: Metallic Grey 2CM 49,75x99,55 cm

Metal

Colours | Colores | Couleurs | Farben



Metallic Brown



Metallic Green



Metallic Grey



Metallic White

Porcelain | Porcelánico | Grés Cérame | Feinsteinzeug
 Rectified | Rectificado | Rectifié | Rektifiziert
 Moderate Variation | Moderada Variación | Variation Modérée | Leichte bis moderate Farbvariation

Size & Thickness | Formato & Espesor | Format & Épaisseur | Format & Dicke

20MM

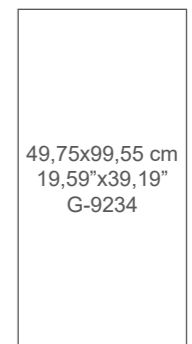

Outdoor Anti-Slip Value | Valor Anti-Slip | Valeur Antidérapantes | Anti-Rutsch-Wert

UNE-ENV 12633

CLASE 3

DIN 51130

R11 A+B+C

ANSI A 137.1

DCOF>0.42

BS 7976

PTV > 36





Outdoor Tile: Corten Graphite Natural Tangram - Corten Oxidum 2CM 49,75x99,55 cm
Indoor Tile 1CM: Corten Oxidum Natural 49,75x99,55 cm

Metal

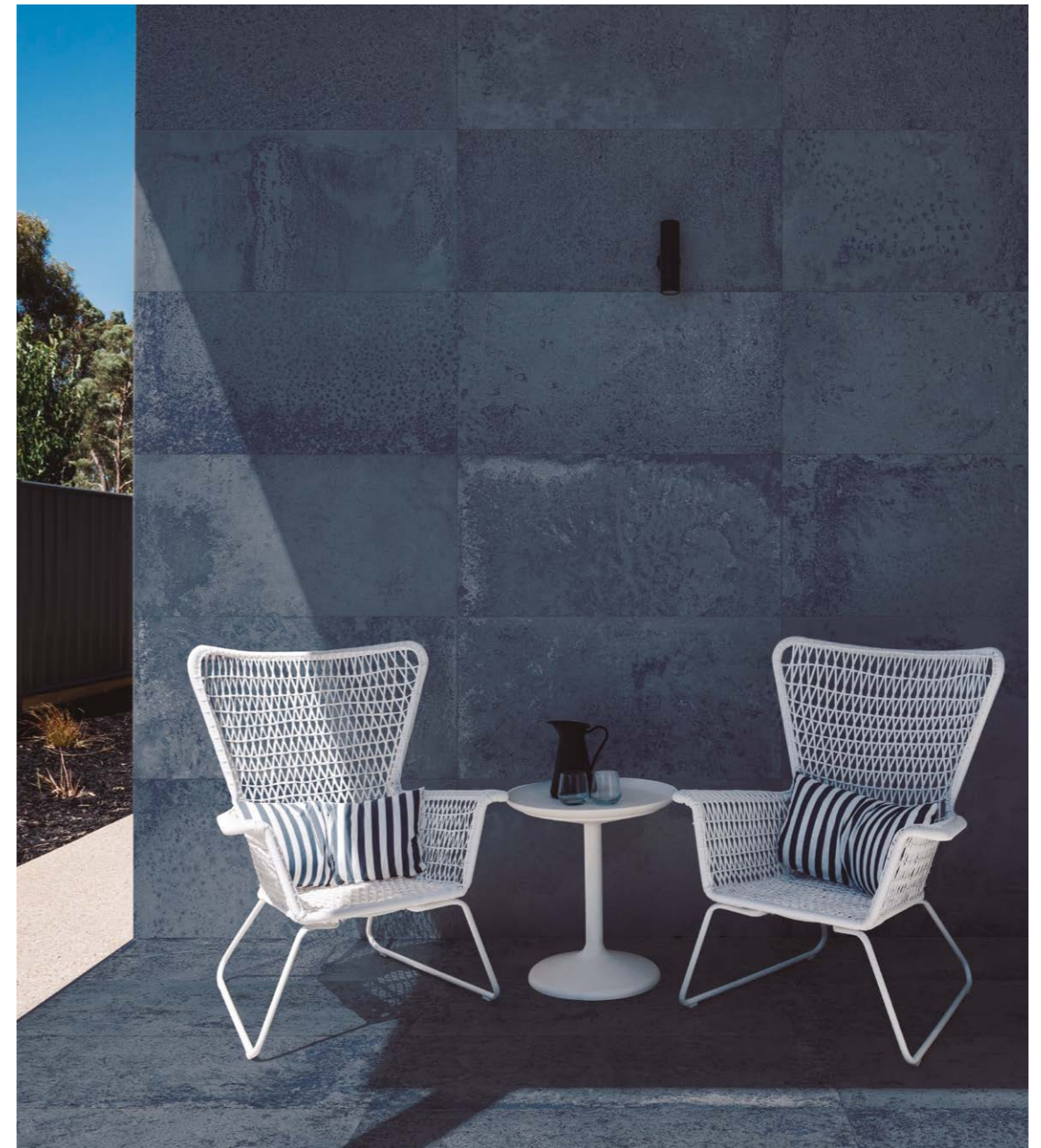

Floor & Wall: Corten Sapphire 2CM 49,75x99,55 cm

OUTDOOR PORCELAIN SLABS 20MM & 10MM | CERÁMICA 20MM & 10MM EXTERIOR

Corten

Metal



Colours | Colores | Couleurs | Farben



Corten Graphite



Corten Oxidum



Corten Iron



Corten Sapphire

Porcelain | Porcelánico | Grés Cérame | Feinsteinzeug
 Rectified | Rectificado | Rectifié | Rektifiziert
 High Variation | Contraste de Tonalidad | Variation Forte | Hohe Farbvariation

Size & Thickness | Formato & Espesor | Format & Épaisseur | Format & Dicke

20MM

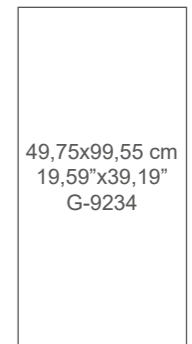

Outdoor Anti-Slip Value | Valor Anti-Slip | Valeur Antidérapantes | Anti-Rutsch-Wert

UNE-ENV 12633

CLASE 3

DIN 51130

R11 A+B+C

ANSI A 137.1

DCOF>0.42

BS 7976

PTV > 36



Floor: Corten Sapphire 2CM 49,75x99,55 cm

On Plots

Our tiles can be easily installed on raised floor systems to provide drainage of rain water. Just ensure that the area to be installed is leveled, compact and can support the weight.

Nuestras baldosas son fácilmente instalables en sistemas de suelo sobreelevado mediante plots, lo que facilita el drenaje de agua. Debe asegurarse, antes de proceder a la instalación, de tener un área nivelada, compacta y que pueda soportar el peso de las baldosas.

Nos carreaux sont facilement installables dans des systèmes de plancher surélevé à l'aide de plots, qui facilite le drainage de l'eau. Avant de procéder à l'installation, vous devez vous assurer que vous disposez d'une surface plane, compact et capable de supporter le poids des carreaux.

Unsere Fliesen können problemlos auf Drainagesysteme verlegt werden, um die perfekte Ableitung von Regenwasser zu gewährleisten.

Plots Information

References	Height Adjustment. Regulación Altura	Unit Price. Precio Unitario	Allowable Load. Carga Admisible
Plot Snr 15	15 mm (fix. fija)	G-2039	6000 kg
Plot Sr 65/100	de 65 a 100 mm	G-2075	2500 kg
Plot Sr 100/130	de 100 a 130 mm	G-2079	2500 kg
Plot Sr 130/220	de 130 a 220 mm	G-2085	2200 kg
Plot Sr 220/310	de 220 a 310 mm	G-2100	2000 kg

Average Quantity Plots / m2

SIZE TILE	PLOTS/M2
50x100 cm	4,5 units/m2

Estimation. Possible variations depending on project. Estimación. Posibles variaciones según proyecto.

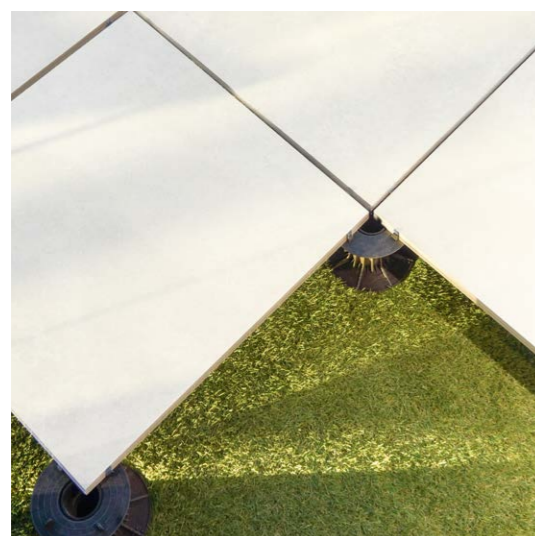

Traditional Installation

The traditional adhesive placement on the filler layer is ideal for paving exterior passable areas, such as access ramps, parkings, patios... This type of placement provides a high resistance to dynamic and concentrated loads. It is very practical for residential, commercial and public areas.

La colocación tradicional con adhesivo sobre la capa de relleno es idónea para pavimentar áreas transitables exteriores, como rampas de acceso, aparcamientos, patios... Este tipo de colocación proporciona una elevada resistencia a las cargas dinámicas y concentradas. Resulta muy práctico para ámbitos residenciales, comerciales y públicos.

La pose traditionnelle avec adhésif sur la couche de remplissage est idéale pour le pavage des zones piétonnes extérieures, tels que rampes d'accès, parkings, patios ... Ce type de placement offre une haute résistance aux charges dynamiques et concentrées. Très pratique pour les zones résidentielles, commerciale et publique.

Auch die traditionelle Verlegung mit Kleber ist ideal für die Verlegung von befahrbaren Außenbereichen, wie z. B. Zufahrten, Rampen, Parkplätzen, etc... Diese Art der Verlegung bietet einen hohen Widerstand gegen dynamische und konzentrierte Lasten.

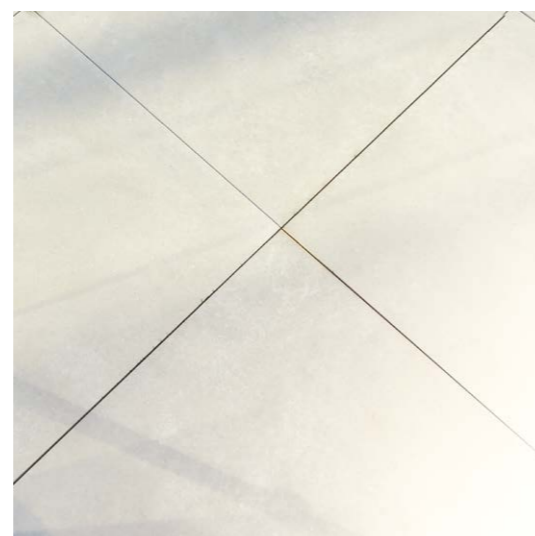

Over Gravel

The placement over gravel is a practical and versatile solution that is characterized by a contemporary aesthetic, ideal for enhancing roads, pedestrian walkways and rest areas. Before installing the floor, make sure the floor is level and compacted. Once conditioned, install the tiles as you prefer, providing a generous joint between them.

La colocación sobre grava constituye una solución práctica y versátil que se caracteriza por constituir una estética contemporánea, idónea para realzar caminos, pasarelas peatonales, patios y zonas de descanso. Antes de proceder a la instalación del pavimento, asegúrese de que el suelo está nivelado y compactado. Una vez acondicionado, instale las baldosas como prefiera, dejando una junta generosa entre ellas.

La pose sur gravier constitue une solution pratique et polyvalente qui se caractérise par la constitution d'une esthétique contemporaine, idéale pour mettre en valeur les allées, les passages piétons, les patios et les aires de repos. Avant de procéder à l'installation du revêtement, assurez-vous que le sol est de niveau et compacté. Une fois conditionné, installez les carreaux à votre guise, en laissant un joint généreux entre eux.

Ebenso die Verlegung im Kiesbett ist eine praktische und vielseitige Lösung, die sich durch eine zeitgemäße Ästhetik auszeichnet, ideal zur Aufwertung von Straßen, Fußgängerwegen und Rastplätzen. Vergewissern Sie sich vor dem Verlegen des Bodens, dass der Boden eben und verdichtet ist. Nach der Konditionierung verlegen Sie die Fliesen wie gewünscht, wobei Sie eine großzügige Fuge zwischen den Fliesen vorsehen.



Over Grass

The direct placement of the 2cm tiles on grass allows to create walkways and paths in areas to integrate them in a green environment as well as in various architectural contexts. Especially recommended for gardens, paths and paths before homes, terraces, parks and public recreation.

La colocación directa de las baldosas de 2cm sobre hierba permite crear pasarelas y caminos en áreas para integrarlas tanto en un entorno verde como en diversos contextos arquitectónicos. Especialmente recomendable para en jardines, sendas y caminos ante viviendas, terrazas, en parques y espacios públicos de ocio.

La pose direct des carreaux de 2 cm sur l'herbe permet de créer des allées et des sentiers dans les zones pour les intégrer à la fois dans un environnement verdoyant et dans divers contextes architecturaux. Spécialement recommandé pour les jardins, les sentiers et les chemins devant les maisons, les terrasses, dans les parcs et les espaces publics de loisirs.

Und die direkte Verlegung der 2-cm-Fliesen auf Rasen ermöglicht es, Gehwege und Pfade in Bereichen zu schaffen, in einer grünen Umgebung. Besonders empfohlen für Gärten, Wege bzw. Wege vor Häusern, Terrassen, Parks und öffentlichen Erholungsgebieten.





Traditional Installation



On Plots

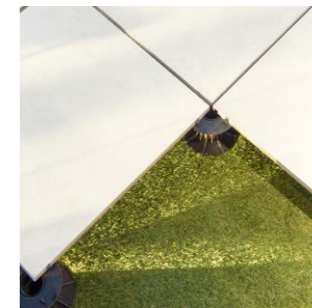

Over Grass



Floor: Camper Ash 2 cm 49,75x99,55 cm - Camper Ash Grid - Camper Ash Tipo L

Decor Shaped Pieces

Our selection of decorative pieces in 20mm thick porcelain for outdoor use allows the conception of outdoor areas and promenades of great design. These five exclusive shapes trapezio, esagono, poligono, palma and arco are customizable in any of the models presented in our selection of outdoor porcelain for outdoor spaces of all dimensions.

Nuestra gama de piezas decorativas en porcelánico de 2cm de espesor para exterior permite crear zonas de exterior y paseos de gran diseño. Estas cinco formas exclusivas trapezio, esagono, poligono, palma y arco son customizables en cualquiera de los modelos presentados en nuestra selección de porcelánico para exteriores para espacios de todas las dimensiones.

Notre gamme de pièces décoratives en porcelaine de 2 cm d'épaisseur pour l'extérieur vous permet de créer des zones extérieures et promenades possédant de grands designs. Ces cinq formes uniques trapèze, hexagone, polygone, palmier et arches sont personnalisables dans l'un des modèles présentés de notre sélection de grés cérame pour extérieur pour des espaces de toutes les dimensions.

Unsere Auswahl an Dekoren aus 20 mm Feinsteinzeug, ermöglicht Konzeptionen für den Außenbereich bzw. Promenaden mit außergewöhnlichen Designs. Unsere fünf exklusiven Formen - trapezio, esagono, poligono, palma und arco - sind auf alle Modelle anpassbar.

Trapezio

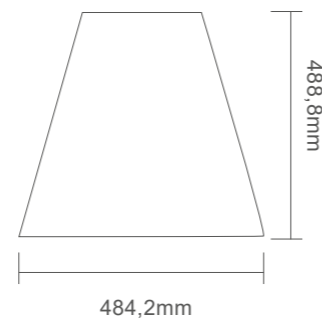

Image showing:
Attila Grey Outdoor 2cm
G-2303

Esagono

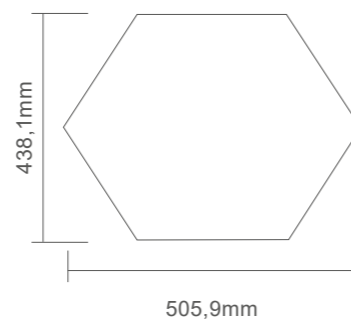

Image showing:
Corten Sapphire Outdoor 2cm
G-2323

Decor Shaped Pieces

Polígono

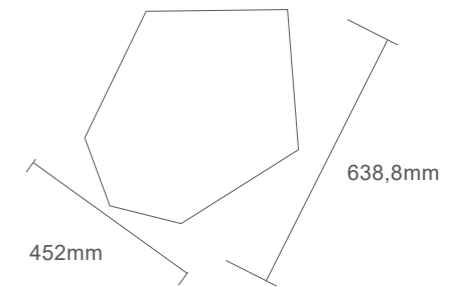

Image showing:
DStone Sand Music Outdoor 2cm
DStone Ash Lekue Outdoor 2cm

G-2355

Palma

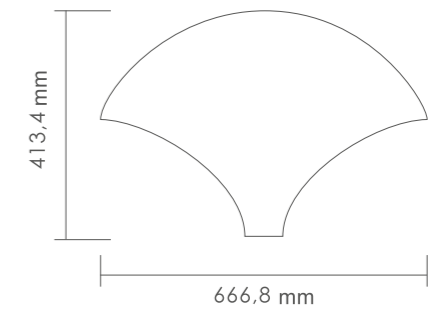

Image showing:
Metallic White Outdoor 2cm
Metallic Green Outdoor 2cm

G-2355

Arco

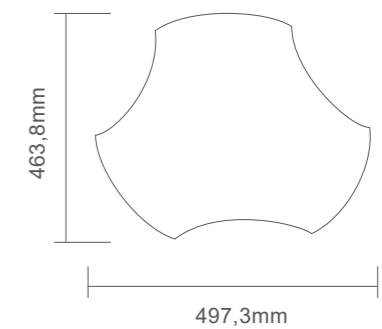
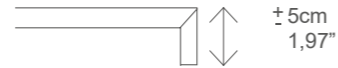
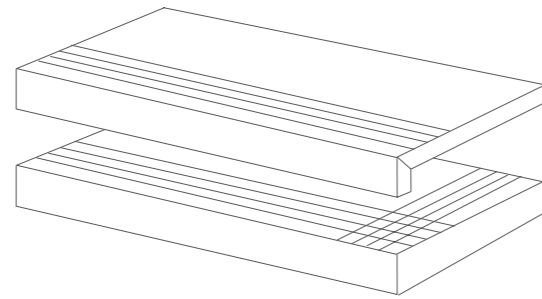

Image showing:
Bohemian Blend Outdoor
G-2355

2cm Step Tiles

Step Type L 2cm | Angular Type L 2cm



44x99,55 cm - 17,32"x39,19"
44x100 cm - 17,32"x39,37"
44x99,55 cm - 17,32"x39,19"
44x100 cm - 17,32"x39,37"

G-2609
G-2609
G-2815
G-2815

Rectified | Rectificado
Rectified | Rectificado

Step 45° 2cm

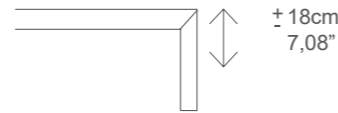
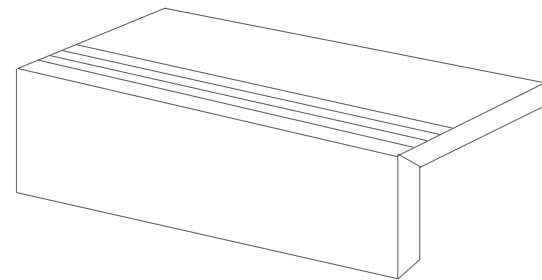

31x99,55 cm - 12,20"x39,19"
31x100 cm - 12,20"x39,37"

G-2623
G-2623

Rectified | Rectificado

*Steps Tiles made to measure and available for all existing references in this catalogue. Grooves optional.
Steps realizados a medida y disponibles para todas las referencias de este catálogo. Ranurado opcional.

*Available in all colours of collections

1cm Step Tiles

Step Type Gradone 1cm | Angular Type Gradone 1cm

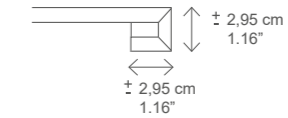
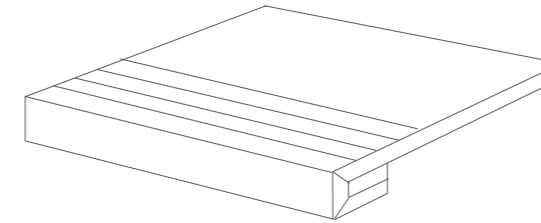

49,75x99,55 cm - 19,59"x39,19"
49,75x99,55 cm - 19,59"x39,19"
99,55x99,55 cm - 37,01"x39,19"
99,55x99,55 cm - 37,01"x39,19"
59,2x59,2 cm - 23,45"x23,45"
59,2x59,2 cm - 23,45"x23,45"

G-2655
G-2723
G-2723
G-2779
G-2559
G-2609

Rectified | Rectificado
Rectified | Rectificado
Rectified | Rectificado
Rectified | Rectificado

Step Type 1cm | Angular Type 1cm

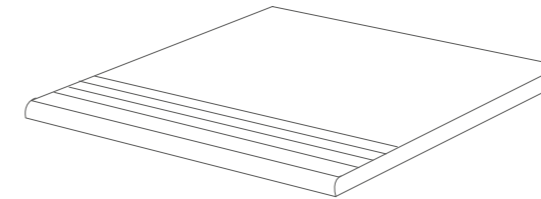

49,75x99,55 cm - 19,59"x39,19"
49,75x99,55 cm - 19,59"x39,19"
99,55x99,55 cm - 37,01"x39,19"
99,55x99,55 cm - 37,01"x39,19"
59,2x59,2 cm - 23,3"x23,3"
59,2x59,2 cm - 23,3"x23,3"

G-2337
G-2375
G-2541
G-2623
G-2197
G-2281

Rectified | Rectificado
Rectified | Rectificado
Rectified | Rectificado
Rectified | Rectificado

Step Type L 1cm | Angular Type L 1cm

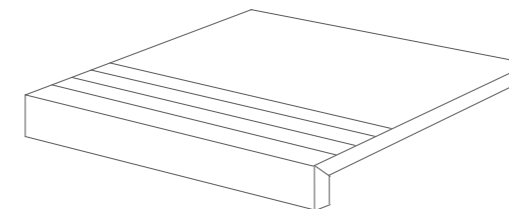

44x99,55 cm - 17,32"x39,19"
44x99,55 cm - 17,32"x39,19"
94x99,55 cm - 37,01"x39,19"
94x99,55 cm - 37,01"x39,19"
54x59,2 cm - 21,26"x23,45"
54x59,2 cm - 21,26"x23,45"

G-2503
G-2585
G-2609
G-2815
G-2375
G-2585

Rectified | Rectificado
Rectified | Rectificado
Rectified | Rectificado
Rectified | Rectificado

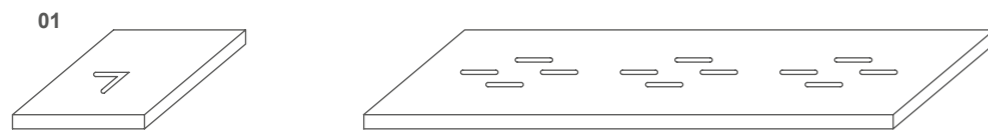
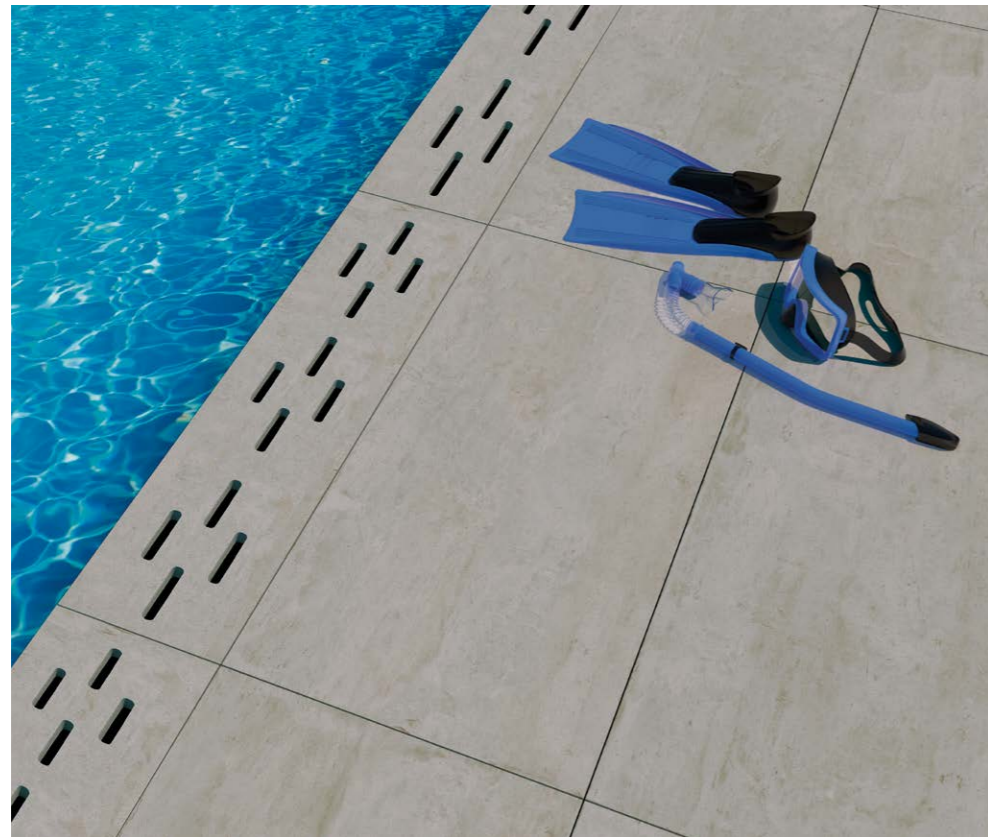

01
Corner 24,75 x 24,75cm G-2171

Grid 24,75 x 99,55 cm | 24,75x100cm G-2375

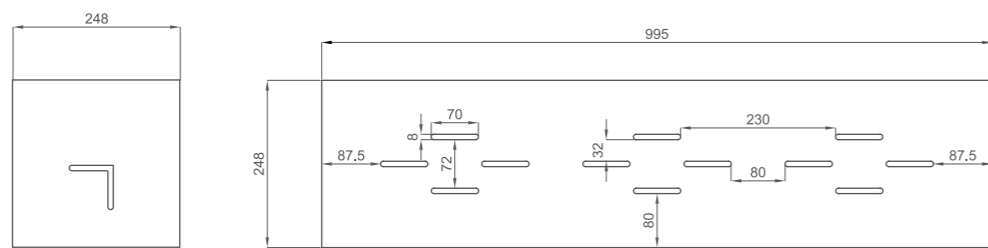

Floor: Brave Grey 2 cm 49,75x99,55 cm - Brave Grey Grid

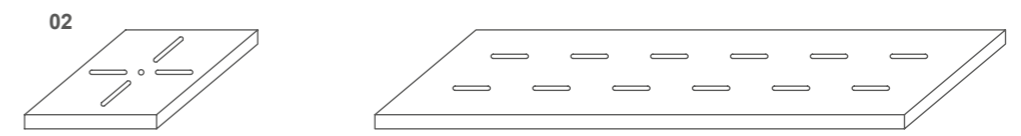

02
Corner 24,75 x 24,75cm G-2171

Grid 24,75 x 99,55 cm | 24,75x100cm G-2375

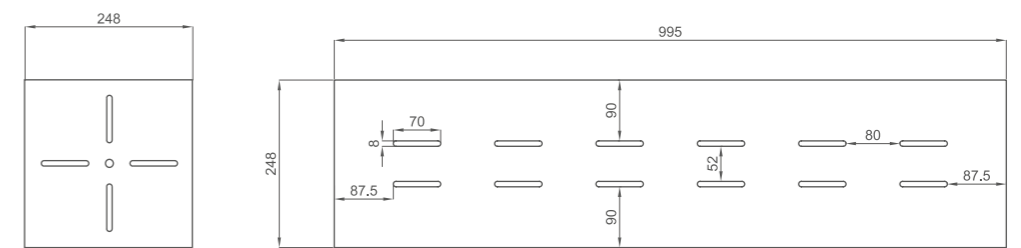

Floor: Cotto Rosso 2 cm 50x100 cm

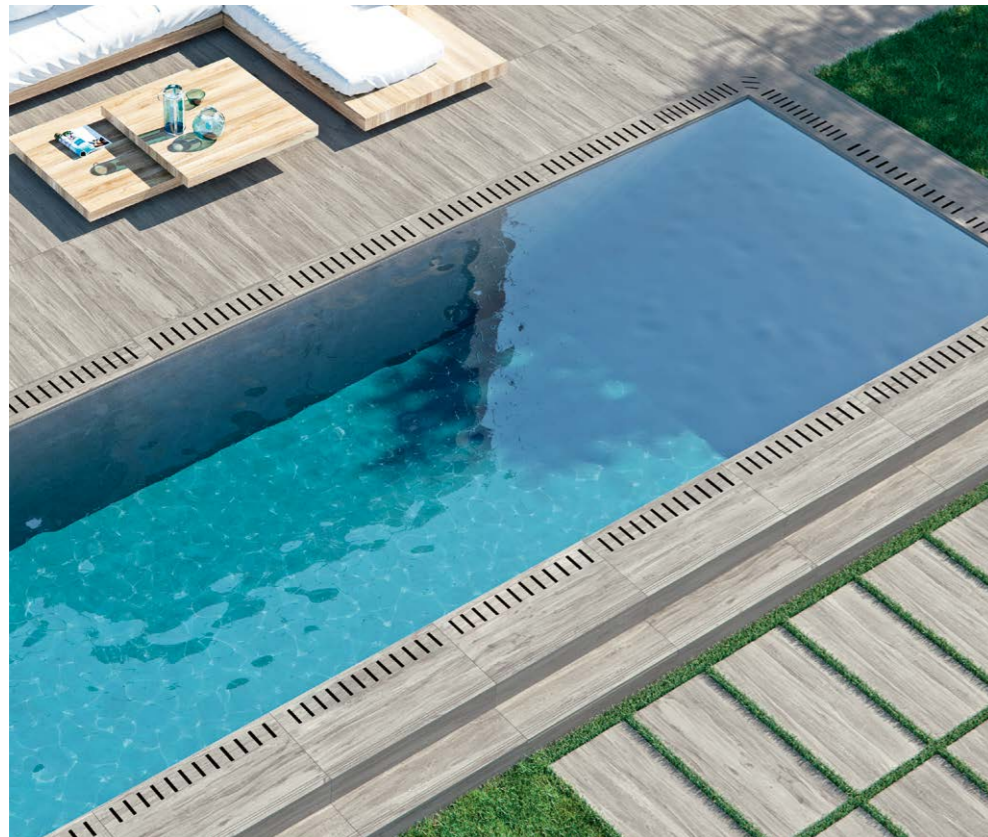

03

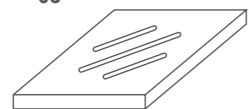

Corner 24,75 x 24,75cm G-2171

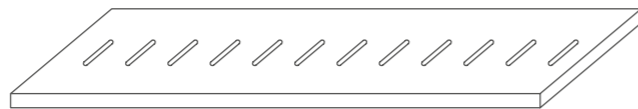

Grid 24,75 x 99,55 cm | 24,75x100cm G-2375

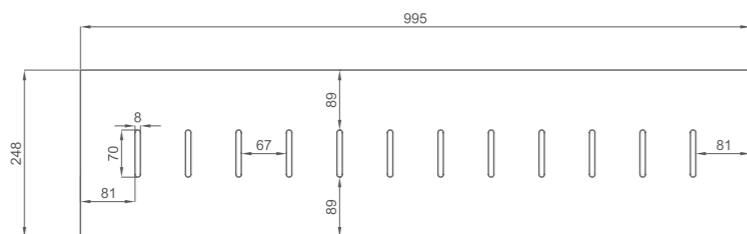
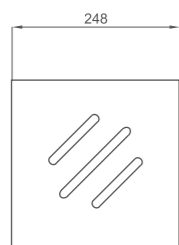

Floor: Camper Ash 2 cm 49,75x99,55 cm - Camper Ash Grid - Camper Ash Tipo L

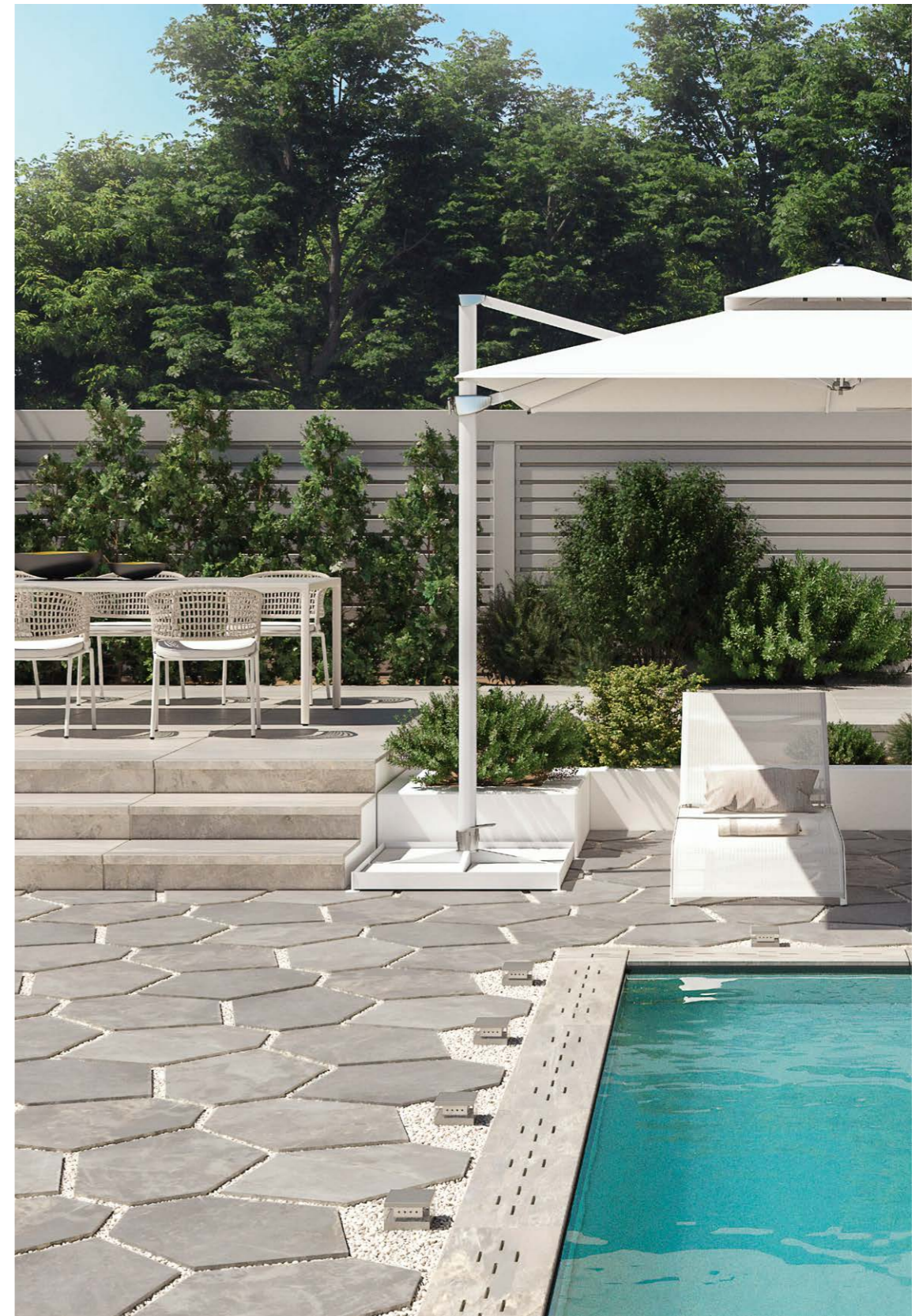

Floor: Dstone Ash Lekue 2CM 49,75x99,55 cm_Tipo L_Grid_Esagono

Packing List



Base Tiles	Format & Thickness	Unit	Boxes/Pallet	m ² /Pallet	m ² /Box	Pieces/Box	Kg/Pallet	Kg/Box
Attila 2 CM	49,75x99,55x2 cm	m ²	36	17,82	0,495	1	840	22,40
Attila 1 CM	49,75x99,55x1 cm	m ²	27	40,12	1,486	3	944	34,10
Brave 2 CM	49,75x99,55x2 cm	m ²	36	17,82	0,495	1	840	22,40
Studio 2 CM	49,75x99,55x2 cm	m ²	36	17,82	0,495	1	840	22,40
Studio 1 CM	99,55x99,55x1 cm	m ²	40	39,64	0,991	1	991	23,88
Harlem 2 CM	49,75x99,55x2 cm	m ²	36	18	0,5	1	845	22,80
Dstone 2 CM	49,75x99,55x2 cm	m ²	36	17,82	0,495	1	840	22,40
Dstone 1 CM	99,55x99,55x1 cm	m ²	40	39,64	0,991	1	991	23,88
Lithops 2 CM	49,75x99,55x2 cm	m ²	36	17,82	0,495	1	840	22,40
Recover 2 CM	49,75x99,55x2 cm	m ²	36	17,82	0,495	1	840	22,40
Recover 1 CM	49,75x99,55x1 cm	m ²	27	40,12	1,486	3	941	34,10
Ronda 2 CM	49,75x99,55x2 cm	m ²	36	17,82	0,495	1	840	22,40
Ronda 1 CM	49,75x99,55x1 cm	m ²	27	40,12	1,486	3	944	34,10
Ronda 1 CM	99,55x99,55x1 cm	m ²	40	39,64	0,991	1	911	23,88
Bohemian 2 CM	49,75x99,55x2 cm	m ²	36	17,82	0,495	1	840	22,40
Carpet 2 CM	50x100x2 cm	m ²	36	18	0,5	1	845	22,80
Tex 2 CM	49,75x99,55x2 cm	m ²	36	17,82	0,495	1	840	22,40
Metallic 2 CM	49,75x99,55x2 cm	m ²	36	17,82	0,495	1	840	22,40
Corten 2 CM	49,75x99,55x2 cm	m ²	36	17,82	0,495	1	840	22,40
Cotto 2 CM	50x100x2 cm	m ²	36	18	0,5	1	845	22,80
Cotto 1 CM	59,2x59,2x1 cm	m ²	36	50,47	1,402	4	1153	31,40
Camper 2 CM	49,75x99,55x2 cm	m ²	36	17,82	0,495	1	840	22,40
Altea 2CM	49,75x99,55x2 cm	m ²	36	17,82	0,495	1	840	22,40

Step Tiles 2CM	Format & Thickness	Unit	Boxes/Pallet	m ² /Pallet	m ² /Box	Pieces/Box	Kg/Pallet	Kg/Box
Type L	44x100 & 44,95x2 cm	m ²	24	21,03	0,876	2	1065	44,30
Angular Type L	44x100 & 44,95x2 cm	m ²	24	10,52	0,438	1	566	23,54

Swimming special pieces 2CM	Format & Thickness	Unit	Boxes/Pallet	m ² /Pallet	m ² /Box	Pieces/Box	Kg/Pallet	Kg/Box
Grid	24,75x99,55x2 cm	m ²	36	17,75	0,493	2	795	22,06
Grid Corner	24,75x24,75x2 cm	m ²	36	8,82	0,245	4	398	11,03

Cerámicas Aparici S.A. does not take any responsibility of printing mistakes in any data of this catalogue. Check and confirm the data with CERÁMICAS APARICI S.A. before any order. All technical characteristics and specifications are based on the available information at the printing moment, they can suffer alterations without warning according to changes in markets, in technological innovations or any other factor. CERÁMICAS APARICI S.A. has the right to modify them without any responsibility or any commitment.

Cerámicas Aparici SA no asume ninguna responsabilidad por errores de impresión en cualquier dato reflejado en el presente catálogo. Por tal motivo, para la realización de cualquier pedido se solicita que sean confirmados a Cerámicas Aparici SA o a su distribuidor. Todas las características y especificaciones técnicas están basadas en la información disponible al momento de la impresión del presente catálogo y podrán cambiar o variar sin previo aviso de acuerdo a las circunstancias del mercado y/o a las innovaciones tecnológicas y/o a cualquier factor. CERÁMICAS APARICI SA, se reserva el derecho a modificarlos en cualquier momento sin incurrir en ninguna obligación, ni responsabilidad.

Technical Characteristics

20mm

TECHNICAL CHARACTERISTICS CARACTERÍSTICAS TÉCNICAS	STANDARD METHOD MÉTODO DE LA NORMA	STANDARD PRESCRIBED VALUES VALOR PRESCRITO POR LA NORMA	2CM COLLECTIONS COLECCIONES 2CM
LENGTH AND WIDTH LONGITUD Y ANCHURA	ISO 10545-2	±0,6% max.	±0,2% max.
RECTANGULARITY RECTANGULARIDAD	ISO 10545-2	±0,5% max.	±0,5% max.
STRAIGHTNESS OF SIDES RECTITUD DE LOS LADOS	ISO 10545-2	±0,5% max.	±0,5% max.
SURFACE FLATNESS PLANITUD	ISO 10545-2	±0,5% max.	±0,5% max.
THICKNESS ESPESOR	ISO 10545-2	±5% max.	±5% max.
PHYSICAL PROPERTIES PROPIEDADES FÍSICAS			
WATER ABSORPTION ABSORCIÓN DE AGUA	ISO 10545-3	≤0.5%	<0.2%
BREAKING STRENGTH, IN N CARGA DE ROTURA, EN N	ISO 10545-4	≥1300 N	>10.000 N
MODULUS OF RUPTURE RESISTENCIA A LA FLEXIÓN	ISO 10545-4	≤35 N/mm ²	> 40 N/mm ²
RESISTANCE THERMAL SHOCK RESISTENCIA AL CHOQUE TÉRMICO	ISO 10545-9	No surface defects should be visible No debe presentar defectos superficiales visibles	Resistant Resistente
RESISTANCE TO CRAZING RESISTENCIA AL CUARTEO	ISO 10545-11	No surface defects or cracks should be visible No debe presentar defectos ni grietas superficiales visibles.	Resistant Resistente
FROST RESISTANCE RESISTENCIA A LA HELADA	ISO 10545-12	There should be no colour variations No debe presentar variaciones de color	Frost Resistant Resistente a la helada
SLIP RESISTANCE RESISTENCIA AL DESLIZAMIENTO	DIN 51130 UNE 41901 EX		R11 Clase 3 *
COLOUR RESISTANCE TO LIGHT RESISTENCIA DEL COLOR A LA LUZ	DIN 51094	There should be no colour variations No debe presentar variaciones de color	No variations in colour and gloss. Sin variaciones de color y brillo
CHEMICAL PROPERTIES PROPIEDADES QUÍMICAS			
CHEMICAL RESISTANCE RESISTENCIA QUÍMICA Resistance to household cleaning products and swimming pool salts. Resistencia a productos domésticos y sales para piscinas	ISO 10545-13	Min. GB	GA
RESISTANCE TO STAINING RESISTENCIA A LAS MANCHAS	ISO 10545-14	Min.3	5

10mm

TECHNICAL CHARACTERISTICS CARACTERÍSTICAS TÉCNICAS	STANDARD METHOD MÉTODO DE LA NORMA	STANDARD PRESCRIBED VALUES VALOR PRESCRITO POR LA NORMA	2CM COLLECTIONS COLECCIONES 2CM
LENGTH AND WIDTH LONGITUD Y ANCHURA	ISO 10545-2	±0,6% max.	±0,2% max.
RECTANGULARITY RECTANGULARIDAD	ISO 10545-2	±0,5% max.	±0,5% max.
STRAIGHTNESS OF SIDES RECTITUD DE LOS LADOS	ISO 10545-2	±0,5% max.	±0,5% max.
SURFACE FLATNESS PLANITUD	ISO 10545-2	±0,5% max.	±0,5% max.
THICKNESS ESPESOR	ISO 10545-2	±5% max.	±5% max.
PHYSICAL PROPERTIES PROPIEDADES FÍSICAS			
WATER ABSORPTION ABSORCIÓN DE AGUA	ISO 10545-3	≤0.5%	<0.2%
BREAKING STRENGTH, IN N CARGA DE ROTURA, EN N	ISO 10545-4	≥1300 N	>2.200 N
MODULUS OF RUPTURE RESISTENCIA A LA FLEXIÓN	ISO 10545-4	≤35 N/mm ²	> 40 N/mm ²
RESISTANCE THERMAL SHOCK RESISTENCIA AL CHOQUE TÉRMICO	ISO 10545-9	No surface defects should be visible No debe presentar defectos superficiales visibles	Resistant Resistente
RESISTANCE TO CRAZING RESISTENCIA AL CUARTEO	ISO 10545-11	No surface defects or cracks should be visible No debe presentar defectos ni grietas superficiales visibles.	Resistant Resistente
FROST RESISTANCE RESISTENCIA A LA HELADA	ISO 10545-12	There should be no colour variations No debe presentar variaciones de color	Frost Resistant Resistente a la helada
SLIP RESISTANCE RESISTENCIA AL DESLIZAMIENTO	DIN 51130 UNE 41901 EX		R11 Clase 3 *
COLOUR RESISTANCE TO LIGHT RESISTENCIA DEL COLOR A LA LUZ	DIN 51094	There should be no colour variations No debe presentar variaciones de color	No variations in colour and gloss. Sin variaciones de color y brillo
CHEMICAL PROPERTIES PROPIEDADES QUÍMICAS			
CHEMICAL RESISTANCE RESISTENCIA QUÍMICA Resistance to household cleaning products and swimming pool salts. Resistencia a productos domésticos y sales para piscinas	ISO 10545-13	Min. GB	GA
RESISTANCE TO STAINING RESISTENCIA A LAS MANCHAS	ISO 10545-14	Min.3	5

aparici



T. +34 964 701 010

E: ceramicas@aparici.com

W. www.aparici.com



@ceramicas_aparici



@apariciceramicas



ceramicas-aparici



ceramicas_aparici

Carretera Castellón - Alcora km.12 - 12110 Alcora (Castellón - Spain)

Cerámicas Aparici SA does not take any responsibility of printing mistakes in any data of this catalogue. Check and confirm the data with CERÁMICAS APARICI S.A. before any order. All technical characteristics and specifications are based on the available information at the printing moment. they can suffer alterations without warning according to changes in markets, in technological innovations or any other factor. CERÁMICAS APARICI S.A. has the right to modify them without any responsibility or any commitment.

Cerámicas Aparici SA no asume ninguna responsabilidad por errores de impresión en cualquier dato reflejado en el presente catálogo. Por tal motivo, para la realización de cualquier pedido se solicita que sean confirmados a Cerámicas Aparici SA o a su distribuidor. Todas las características y especificaciones técnicas están basadas en la información disponible al momento de la impresión del presente catálogo y podrán cambiar o variar sin previo aviso de acuerdo a las circunstancias del mercado y/o a las innovaciones tecnológicas y/o a cualquier factor. CERÁMICAS APARICI SA, se reserva el derecho a modificarlos en cualquier momento sin incurrir en ninguna obligación, ni responsabilidad.

aparici

www.aparici.com